

TABLETOP SOAP DISPENSER WP191-3



Ø 68 x 310 x 130 mm
stainless steel

- Tabletop soap dispenser in robust, germ-reducing and easy-care stainless steel (AISI 316L).
- Solid stainless steel body; visible surfaces satin finished. Further available surfaces: see below.
- Design height: 62 mm
Outlet height: 37 mm
Projection: 74 mm
- Non-drip soap pump with 500 ml soap bottle in plastics and pressure valve in stainless steel.
- Also available with 250 ml or 1000 ml containers in plastics.
- 500 ml container in stainless steel as an option for a surcharge.
- Designed for standard liquid soaps.
- Refillable from above by unscrewing the top part.
- Wear parts can be replaced as modules.
- Installation dimensions: Ø 22-26 mm, surface thickness max. 40 mm.
- Mounting: With one counternut.
- Delivery includes fixing material.
- Weight, including single package: 0.7 kg



Suggested text for specifications:

Tabletop soap dispenser in stainless steel (AISI 316L) for counter mounting. Solid stainless steel body; visible surfaces satin finished. Non-drip soap pump with 500 ml soap bottle in plastics and pressure valve in stainless steel. Designed for standard liquid soaps. Refillable from above by unscrewing the top part. Delivery includes fixing material.

Dimensions: (with container) 65 x 310 x 130 mm
Design height: 62 mm
Outlet height: 37 mm
Projection: 74 mm

Article No. WP191-3

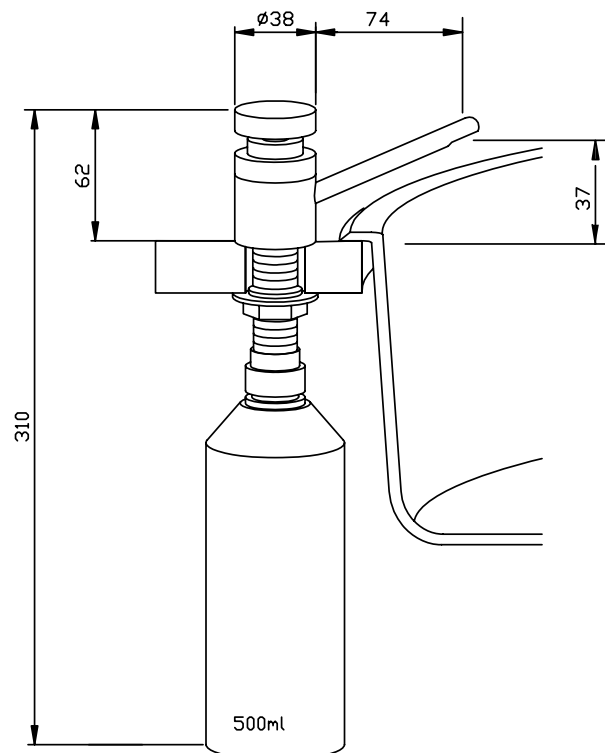

Options	ID No.
Washer / rosette	923 159
Available surfaces	ID No.
satin finished (standard)	924 027
highly polished	931 191

Ernst Wagner GmbH & Co. KG

Ernst-Abbe-Straße 21 · D-72770 Reutlingen · Tel.: +49712151539-0 · Fax: -20
info@wagner-ewar.de · www.wagner-ewar.de

WAGNER
E W A R